

7 Button Zone Control

Full control at your fingertips

Versatile Wall Control available in multiple configurations. 4 to 8 zone dimming, six zones plus All-On/Off, DMX Scene Start, etc. DIP switches provide selection of DMX-512 “start” and “stop” channels.

RJ-45 input and output jacks allow switches to be installed in series for efficient cable runs. 4-pin terminal block allows Occupancy and Daylight Harvesting sensor input, allowing direct communication to the Digital Light Modules.

Easy to install and user-friendly for configuration of rooms or zones.

DIMENSIONS

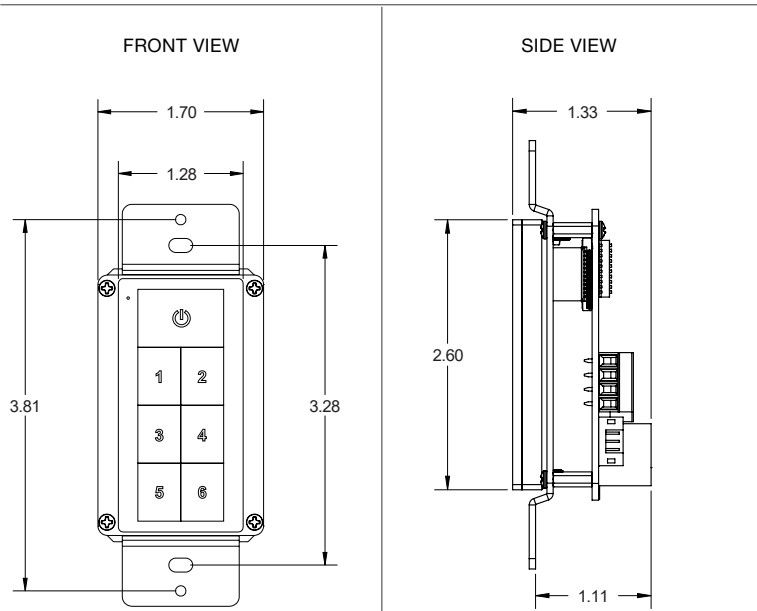

CERTIFICATIONS:

